

SECTION C-C

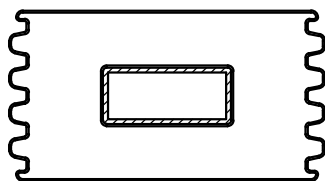

SECTION B-B

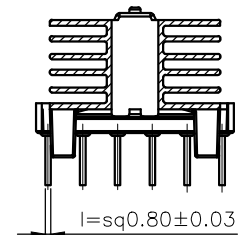
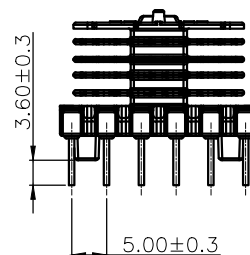
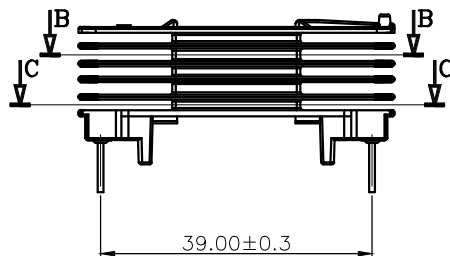
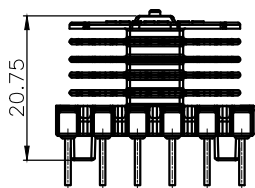
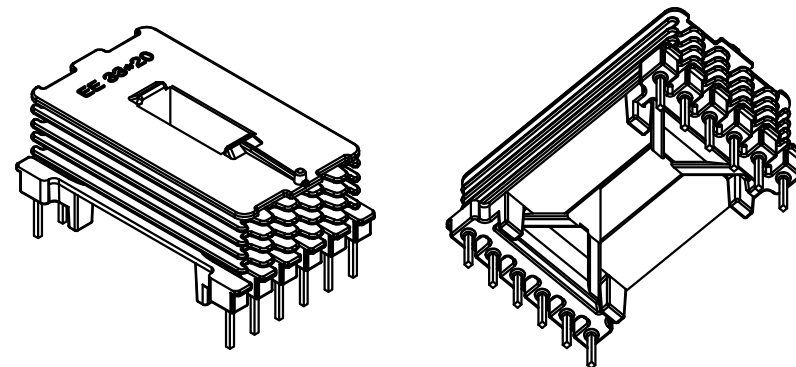
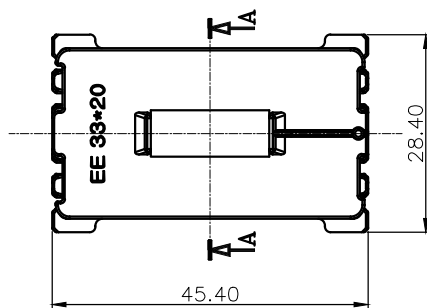
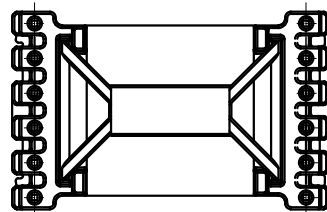

△							
△							
△							
MARK	REVISION NOTE			DATE	DRAWN	CHECKED	APPROVED
DRAWN	CHECKED	APPROVED	MATERIAL: L.C.P (BK)	UL REC. : UL94V-0	THIRD ANGLE PROJ.	SCALE : 1/1	
HK, Yang	SH, Kim	C, Park		DATE : 2012.11.12	TOLERANCE : ±0.2 (Unless otherwise specified)	UNIT : m/m	
주식회사 대흥보빈 DAE HEUNG BOBBIN CO., LTD			TITLE EE 33*20 "V" (12P) 5F		DWG NO DH-121210-2090-00		